

## Investigation of MPPT Methods Used In PV Systems

Yunus Emre Yağan<sup>1</sup>, Kadir Vardar<sup>2\*</sup>, Mehmet Ali Ebeoğlu<sup>3</sup>

<sup>1,2,3</sup>(Department of Electrical and Electronics Engineering, Dumlupınar University, Kütahya, TURKEY)

Corresponding author: Kadir Vardar

---

**Abstract:** In this study, Maximum Power Point Tracking (MPPT) methods are investigated and an analysis of the main MPPT methods is performed. Incremental Conductance, Perturb & Observe, Open-Circuit Voltage, Short-Circuit Current, Fuzzy Logic Controller, which take part in the literature as one of the most commonly used MPPT methods, and hybrid methods based on MPPT methods are investigated. The advantages and disadvantages of the investigated methods are provided. A PV string is modeled with Matlab/Simulink modeling program. The MPPT methods are tested with the modeled PV string and their system performances are compared under the same conditions. Simulation results are given in graphs.

**Keywords:** PV systems, MPPT methods.

---

Date of Submission: 15-03-2018

Date of acceptance: 03-04-2018

---

### I. Introduction

Solar energy, which is considered as one of the most reliable and promising sources among the renewable energy sources, has gained much popularity these days due to its advantages such as being clean, eco-friendly, no fuel cost, demanding low maintenance and repair, quiet operation, high durability, zero input energy cost and containing nonconsumable input energy source [1-3].

Energy production is performed by PV cells in a PV system. In order to establish a PV system with the desired output power, PV cells are connected serially-parallelly to form a PV module, PV modules are connected in series to form a PV string and PV strings are connected in parallel to form a PV array. The structure composed of PV cells of any size used in solar energy production can be called as PV generator. In order to achieve maximum efficiency in PV systems, the system must be operated at the maximum power point (MPP) on the output characteristic curve (V-I and V-P curves). However, that point is found through calculations as characteristic curves of the PV systems are non-linear. MPP is not stable and varies depending on the changes in environmental conditions. In order to determine that point correctly and quickly, various maximum power tracking methods (MPPT) have been developed. The MPPT is implemented in PV systems by controlling the output voltage of the PV generator with a DC-DC converter circuit connected in series to the generator output. There are many types of DC-DC converters used for this purpose. Generally, the boost DC-DC converter is preferred because of its high efficiency, high voltage gain and simple structure [31].

There are many MPPT methods in the literature [3-8]. It has been observed that these methods, which are many in number, are classified in different terms. The various classifications identified in the review studies on MPPT methods are given. In the study given in the reference [3, 25], selected methods are classified as conventional and soft computing. In another study [8,24], MPPT methods are classified as offline, online, and hybrid methods. In another study [40], MPPT methods are found to be divided into five groups, methods based on constant parameters, methods based on measurement and comparison, methods based on trial and error, methods based on mathematical calculation and methods based on intelligent prediction.

In the second section of this study, PV systems and the dependence of a PV string on environmental conditions have been examined. In the third section, MPPT methods which are most frequently discussed in the literature and widely used in practice, have been examined in detail. These methods are Perturb and Observe, Incremental Conductance, Fuzzy Logic Controller, Open-Circuit Voltage and Short-Circuit Current methods. In the fourth section, a PV string, the boost DC-DC converter circuit, a system which has resistive load at the converter output have been modeled through Matlab/Simulink to test the MPPT methods. The MPPT methods have been compared under the same environmental conditions through the modeled test system. The results have been given in graphs. In the fifth section, the results obtained from this study have been evaluated.

### II. PV System

PV systems convert direct sunrays into electrical energy. Electrical energy is produced at the cellular level in PV systems. PV module is formed by connecting the PV cells in series-parallel. In order to increase the output current in a PV module, the cells are connected in parallel while increasing output voltage requires to

connect the cells in series [20]. In addition, the system formed by connecting PV modules in series is called PV string and the system formed by connecting PV strings in parallel are called PV array [3-6].

There are many methods developed in the literature to analyze the output characteristic of the PV system properly. These methods generally emerge as analytical equations that are used to generate the equivalent circuit of a solar cell [9-19]. It is preferred to use an equivalent circuit to analyze the performance of the PV system. The most preferred equivalent circuit model for modeling a solar cell is single-diode model due to the balance between accuracy and simplicity [3,20,21]. The single diode solar cell equivalent circuit model is given in Fig.1.

Single diode equivalent circuit equations:

$$I = I_{ph} - I_d - I_p$$

$$I_{ph} = \left( I_{ph0} + K_i(T - T_o) \right) \frac{G}{G_o}$$

$$I_d = I_s \left( e^{\frac{V_D}{AV_t}} - 1 \right)$$

$$I_s = I_{s0} \left( \frac{T}{T_o} \right)^3 e^{\frac{qE_g}{Ak} \left( \frac{1}{T_o} - \frac{1}{T} \right)}$$

$$V_D = IR_s + V$$

$$V_t = \frac{kT}{q}$$

$$I_p = \frac{IR_s + V}{R_p}$$

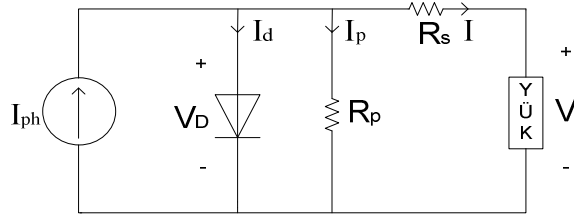

Fig.1 Single diode PV cell equivalent circuit model.

(1)

The given formulas are represented by their meanings as:  $I_{ph}$ :Photon current; $I_d, V_D$ :Diode current and voltage; $V_t$ :Diode thermal voltage; $R_p$ :Shunt resistance; $R_s$ :Series resistance; $I_p$ :Leakage current (current flowing through the shunt resistance );  $I$ :Output current of the PV cell (A);  $V$ :Output voltage of the PV cell (V);  $G$ :Solar irradiation ( $W/m^2$ );  $T$ :Operating cell temperature (K); $K_i$ :Short circuit current temperature coefficient; $I_s$ :Diode saturation current (A);  $q$ : Electron charge ( $1.6 \cdot 10^{-19}$ Coulomb);  $k$ :Boltzmann constant ( $1.38 \cdot 10^{-23}J/K$ ); $E_g$ :Band gap energy of the semiconductor (1.1eV);  $A$ :Diode ideality factor; the "o" sub-index: represents the value of the variable under the Standard Test Conditions (STC, 25 °C and 1000  $W/m^2$ ).The datasheet information of the PV module is given in Standard Test Conditions. In this study, a PV string have been modeled through Matlab/Simulink by connecting three DS-100M PV modules in series to analyze the output characteristics of the PV system and to test the MPPT methods. The referenced DS-100M PV module's nominal power rating is 100W, MPP voltage is 18V, MPP current is 5.55A, open circuit voltage rating is 21.6V, short circuit voltage rating is 6.11A, serial cell number ( $N_s$ ) is 36, maximum system voltage is 1000V, short circuit voltage temperature coefficient ( $K_i$ ) is 0.002and operating range is between  $-40^{\circ}C$  to  $80^{\circ}C$ [22]. The output characteristic of the PV system varies depending on environmental conditions such as solar irradiation ( $G$ ) and temperature ( $T$ ). The effect of solar irradiation and ambient temperature on the output characteristic of the PV string is given in Fig.2. Another environmental condition that affects the output character of the PV string is that the modules in the string receive different solar radiation. This is called partial shading of the PV string. When the PV string is partially shaded, the output characteristic is like Fig.3.

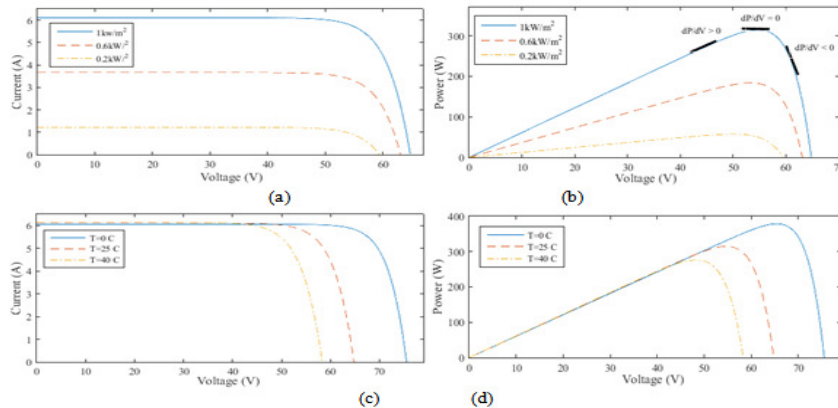
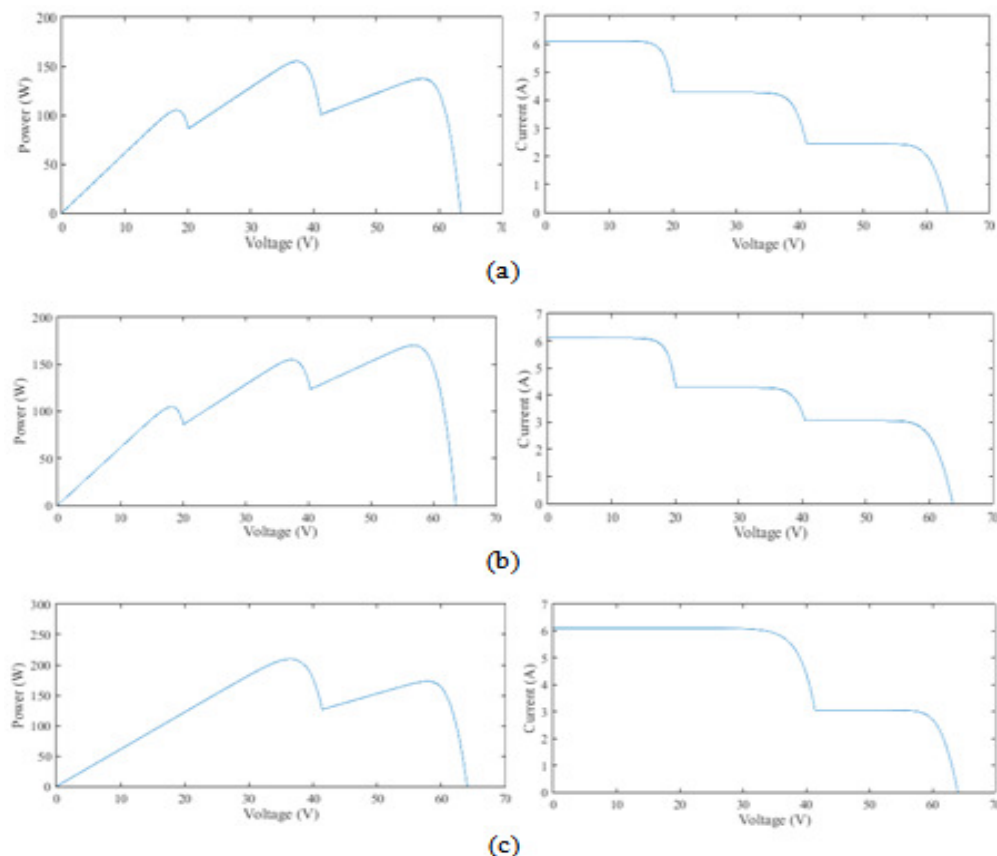

Fig.2 The effect of the changing of the solar irradiation and ambient temperature on V-I and V-P curves of the PV string; a) V-I curve with changing solar irradiation, b) V-P curve with changing solar irradiation, c) V-I curve with changing ambient temperature and d) V-P curve with changing ambient temperature.



**Fig.3** Effects of various partial shadings on V-I and V-P curves; a) Radiation densities of the modules 1, 2 and 3 are respectively 400, 700 and 1000 W/m<sup>2</sup>, b) Radiation densities of the modules 1, 2 and 3 are respectively 1000, 700 and 500 W/m<sup>2</sup>, c) Radiation densities of the modules 1, 2 and 3 are respectively 1000, 1000 and 500 W/m<sup>2</sup>.

It can be seen in the Fig.2 and Fig.3 that the output characteristic of PV string is nonlinear, and it changes in accordance with the environmental conditions. In order to benefit from the string with the highest efficiency, it should be operated at the voltage (V) and current (I) values, which gives the highest power (P) value at the output. These values of the voltage and current of the string are called as the maximum power point voltage ( $V_{mpp}$ ) and the maximum power point current ( $I_{mpp}$ ). MPPT methods have been developed to track continuously these  $V_{mpp}$  and  $I_{mpp}$  points, which are not fixed and also not linearly change. MPPT methods are given in the following section.

### III. MPPT Methods

Perturb and Observe, Incremental Conductance and Fuzzy Logic Controller are the most widely used MPPT methods in the literature. Since the desired efficiency cannot be achieved by only using the MPPT methods, hybrids methods have been adopted. Calculations are usually conducted in two steps, which include several methods, in hybrid methods. In the first step of the hybrid methods, it is aimed to find the approximate Maximum Power Point (MPP) in the fastest way, and in the second step it is aimed to find the MPP exactly and track it continuously. The first step most commonly used in hybrid methods is the short-circuit current method and/or the open-circuit voltage method, while in the second step, the Perturb and Observe, Incremental Conductance and Fuzzy Logic Controller methods are generally preferred [4,23-30].

#### III.I Perturb And Observe Method (P&O)

In this method, the power value is calculated by measuring the operating point voltage and current at the output of the PV generator. The power value is recalculated by changing the reference voltage (or current) value of the boost DC-DC converter, which is at the output of the PV generator. The calculated power values are compared and the value of the reference voltage (or current) is changed in the same direction or vice versa according to the comparison. In this way, the output power of the PV generator is tried to be increased

continuously. The flowchart of this method is as shown in Fig.4. Perturb and Observe method is an iterative method. Its ease of implementation, cost-effectiveness and operating independently from the parameters of PV generator are its major advantages. The disadvantage of this method is that it does not exactly find the MPP and oscillates around the MPP. This causes the maximum power not to be fully utilized. Also, this method is slow because of the fact that it has steady-step. If the step size is selected in large, the dynamic response of the method improves but the amplitude of the oscillations increases. When it is selected in small size, the amplitude of the oscillations decreases, but the dynamic response slows down particularly under rapidly changing environmental conditions and load condition [3,8,24,31].

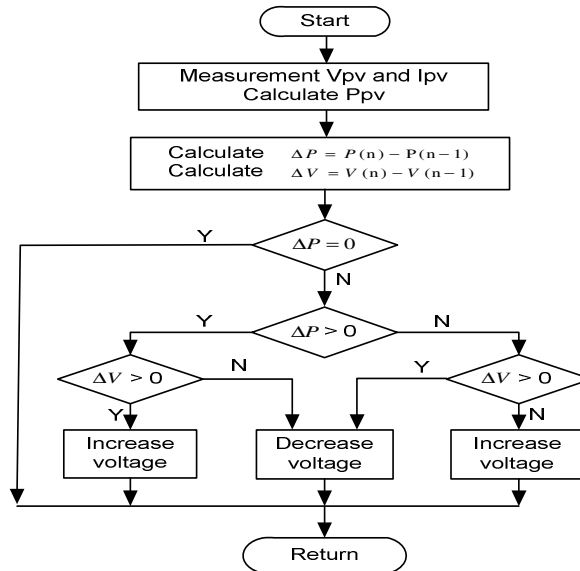

Fig.4 Flowchart of the perturb and observe method.

### III.II Incremental Conductance Method

In this method, the derivative of the generator is used according to the voltage value of the power value at the output of the PV generator. As can be seen in Fig.2(b), the value of this derivative is 0 in MPP, positive in the left of MPP, and negative in the right of MPP. The instantaneous conductance ( $\frac{I}{V}$ ) of the PV generator is compared to incremental conductance ( $\frac{dI}{dV}$ ) through the Equation 5 obtained from that information. Accordingly, the MPP is sought by increasing or decreasing the reference voltage value. The flowchart of this method is as shown in Fig.5.

$$P_{PV} = V_{PV} * I_{PV} \tag{2}$$

$$\frac{dP_{PV}}{dV_{PV}} = I_{PV} + V_{PV} * \frac{dI_{PV}}{dV_{PV}} \tag{3}$$

$$\frac{dP_{PV}}{dV_{PV}} = I_{PV} + V_{PV} * \frac{dI_{PV}}{dV_{PV}} = 0 \text{ at MPP,}$$

$$\frac{dP_{PV}}{dV_{PV}} = I_{PV} + V_{PV} * \frac{dI_{PV}}{dV_{PV}} > 0 \text{ left of MPP}$$

$$\frac{dP_{PV}}{dV_{PV}} = I_{PV} + V_{PV} * \frac{dI_{PV}}{dV_{PV}} < 0 \text{ right of MPP} \tag{4}$$

If Equation 4 is rearranged;

$$\frac{dI}{dV} = -\frac{I}{V} \text{ at MPP, the reference voltage value is not modified}$$

$$\frac{dI}{dV} > -\frac{I}{V} \text{ left of MPP, the reference voltage value is increased}$$

$$\frac{dI}{dV} < -\frac{I}{V} \text{ 0 right of MPP, the reference voltage value is reduced} \tag{5}$$

The performance of the incremental conductance (INC) method is better than the perturb and observe method under rapidly changing atmospheric conditions. Unless there is a change in environmental conditions, it remains stable at MPP. However, when there is a change in the generator current, the incremental conductance starts to search the MPP again [32,33]. The balance between the MPPT response rate and steady-state accuracy at P&O, which depends on the step size, is also valid for this method. The primary shortcoming of this is that it cannot track MPP under partial shading conditions.

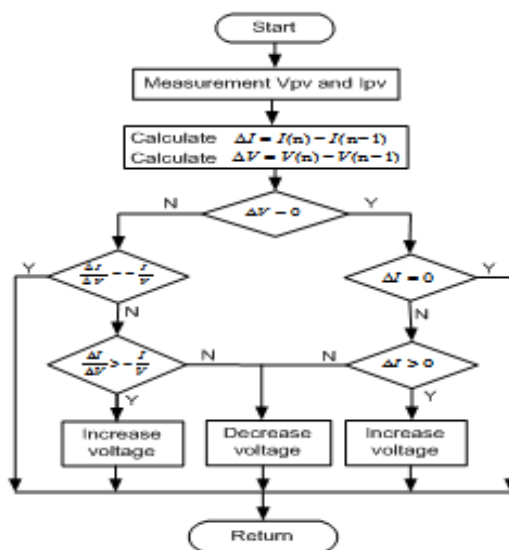

Fig.5 Flowchart of the incremental conductance method.

### III.III Fuzzy Logic Controller

The fuzzy logic controller (FLC) is designed in accordance with the flexible determination of the variables and rules at the modeling stage. Nowadays, the controller has many application areas [34]. The fuzzy logic controller is also widely used in tracking the MPP of the PV generator and the block diagram is as shown in Fig.6. Generally, the inputs of the controller are the error and change in the error given in the Eq. 6 and Eq. 7, respectively. The output can be  $\Delta V$ ,  $\Delta I$ ,  $D$  (duty cycle),  $\Delta D$ ,  $V_{mpp}$  or  $I_{mpp}$ .

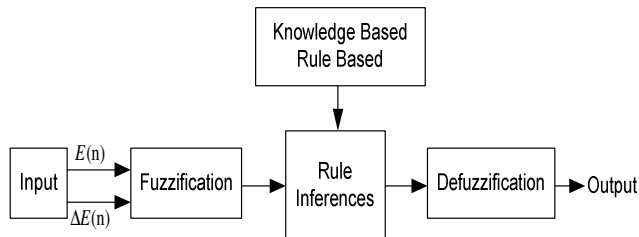

Fig.6 Block diagram of the fuzzy logic controller.

$$E(n) = \frac{P(n) - P(n-1)}{V(n) - V(n-1)} \tag{6}$$

$$\Delta E = E(n) - E(n-1) \tag{7}$$

The main advantages of this controller are the ability to solve nonlinearities, independency of a mathematical model of the PV system, and rapid convergence to the MPP. It is a disadvantage of the controller that the accuracy of the controller output depends largely on rules and membership functions. Because an expert view and experience is required to determine these. Another disadvantage is that the method is likely to stick to a local peak, since  $E(k)=0$  for all peaks under partial shading conditions [3,24,25,35,39].

### III.IV Open Circuit Voltage and Short Circuit Current Methods

In the PV generator, an approximate linear relationship can be established between MPP current and short-circuit current ( $I_{sc}$ ) values and between MPP voltage and open-circuit voltage ( $V_{oc}$ ) values. In these methods, MPP of the PV generator is searched by using this approximate linear relationship. In practice, open circuit voltage value or short circuit current value is measured through the PV generator. The measured value is multiplied by the constant  $k$  to determine the approximate location of the MPP. The open circuit voltage method is as shown in Equation 8 and the short circuit current method is as expressed in Equation 9. These two equations are valid in any environmental condition except for the partial shading condition.

$$V_{mpp} \approx k * V_{oc} \tag{8}$$

$$I_{mpp} \approx k * I_{sc} \tag{9}$$

The main advantages are that they are a practical method for MPPT, that sensor requirements are low, their speed is very high, and that they do not require any derivation. The disadvantages are that the difficulty in obtaining the constant  $k$ , that it is necessary to shade the load periodically to measure the open-circuit voltage value or the short-circuit current value, and that MPP cannot be found, if the PV generator is partially shaded [3,8,24,25]. As they converge the MPP rapidly, they are used as the first step in most of the hybrid methods [4,26,30,23].

### III.V Hybrid MPPT Methods

The above-mentioned 5 methods are the most used MPPT methods. However, efficiency of these methods is not very high and none of them can determine the accurate MPP location when the PV generator is partially shaded. Hybrid methods have been developed to increase the efficiency of these methods and to determine the location of MPP in cases where the PV generator is partially shaded.

Calculations are usually conducted in two steps, which include several methods, in hybrid methods. In the first step, it is aimed to find the approximate Maximum Power Point (MPP) in the fastest way, and in the second step it is aimed to find the MPP exactly and track it continuously [24]. Some hybrid methods used in the literature are given below. In the study given in reference [26], the open-circuit voltage method is used in the first step and the perturb and observe method is used in the second step. In the first step of the study, the open-circuit voltage value of the generator was calculated by Equation 10, which was obtained by using the solar irradiation ( $G$ ), temperature ( $T$ ) and data sheet information without open-circuiting the PV generator. The operating point voltage of the generator was moved to  $V = k * V_{oc}$  point. In the second step, the adaptive step sized P&O method was used, which is determined by Equation 11. When solar irradiation and temperature change, MPP can be tracked accurately through this method. However, when the generator is partially shaded, the open-circuit voltage value of the generator does not change, as can be seen in Fig.3. So, the method will not find the MPP. In Equation 11,  $N$  is a constant parameter, and  $C(n)$  is the step size in  $n$ . sample.

$$V_{oc} = AV_T \ln\left(\frac{I_{ph}}{I_0}\right) \quad (10)$$

$$C(n) = N \log\left|\frac{\Delta P}{\Delta V}\right| \quad (11)$$

The P&O method was used in the hybrid MPPT studies presented in references [27] and [28] at different step sizes in both steps. The P&O method used in the first step has a large step size to get closer to the MPP, and the P&O used in the second step has a small step size to minimize the steady-state errors. The step to be selected was determined by a Fuzzy Logic Controller (FLC). In another study given in reference [29], P&O and FLC were used as hybrids. In this study, step size of P&O was determined by a FLC and a hybrid structure was established. In both hybrid methods, the dynamic response is fast and there are few steady-state errors. In these methods, they will be stuck to a local peak in case of partial shading.

In a hybrid MPPT study given in reference [30], a different open-circuit voltage method was used in the first step, and in the second step, an automatic modulated and current sensorless method similar to the incremental conductance method was used. In order to eliminate the periodic measurement of the open circuit voltage in the first step, the open circuit voltage of the generator is measured for once in the initial phase and this value is used to create a lower and an upper limit to include the MPP voltage (Equation 12). In the first step of the method, the generator voltage is measured and checked whether it is within the limits or not. If it is not within the limits, the duty cycle is roughly increased/decreased and drawn into the limits and passed to the second step (Equation 13). In the second step, the actual MPP is tracked by a method similar to the incremental conductance method by using the generator voltage and duty cycle without using the current sensor (Equation 14). Using only one sensor (voltage sensor) in the suggested method has reduced the complexity and cost of the method. The method has provided better results under varying solar irradiation. In case the PV generator is partially shaded, the method cannot find the MPP because the MPP voltage may not be within the limits determined in this study.

Setting the limits:

$$\begin{aligned} V_{mppL} &= k_1 * V_{oc} \\ V_{mppH} &= k_2 * V_{oc} \end{aligned} \quad (12)$$

Roughly bringing the PV array voltage within the limits:

$$\begin{cases} V_{pv} < V_{mppL}, & D = D - \Delta D \\ V_{mppL} < V_{pv} < V_{mppH}, & \text{second step} \\ V_{pv} > V_{mppH}, & D = D + \Delta D \end{cases} \quad (13)$$

The second step, similar to the incremental conductance method:

$$\left\{ \begin{array}{ll} \frac{dV_{pv}}{dD} < -\frac{V_{pv}}{1-D}, & D = D + \Delta D \\ \frac{dV_{pv}}{dD} = -\frac{V_{pv}}{1-D}, & D = D \\ \frac{dV_{pv}}{dD} > -\frac{V_{pv}}{1-D}, & D = D - \Delta D \end{array} \right. \quad (14)$$

In the study given in reference [23], a hybrid method is used in which the short circuit current method is applied in the first step and the P&O method is used in the second step. In the first step, a limit to the change of  $k$  constant ( $\Delta k$ ) is determined instead of the periodic measurement of the short-circuit current to avoid power losses and only when this limit is exceeded the new short circuit current  $I_{sc}$  value is measured. The state where  $\Delta k$  exceeds a certain limit is determined by the increase /decrease in the output current when it is operating around found MPP (Equation 15) and when the limit is exceeded, the expression in Equation 15 is updated by reading new  $I_{sc}$  value of the short-circuit current. With this method, the MPP was approached rapidly in various environmental conditions, and the MPP was tracked by minimizing the oscillations with very small step sized P&O. It can be determined through this method that the method will stick to a local peak under partial shading conditions. In another study using the same method [38], it was used with the stand-alone flyback inverter.

$$\Delta k = k(n) - k(n-1) = \frac{I_{pv}(n)}{I_{sc}} - \frac{I_{pv}(n-1)}{I_{sc}} = \frac{\Delta I_{pv}}{I_{sc}} \quad (15)$$

In the first step of the hybrid study presented in reference [4], the V-P curve was scanned in steps of 75% of the open-circuit voltage value of a single module in a generator system, and the power value of the PV generator was measured at each step and the largest location of the power was considered as the approximate MPP and the second step was taken. In the second step, the fuzzy logic controller method was used. The scanning of the V-P curve, which was performed in the first step of the study, was repeated continuously at the intervals of 20-25 seconds. At the end of the first step, approximate global MPP was achieved under all environmental conditions, including partial shading. At the end of the second step, the global MPP was found. The reason for selecting the steps of the study in proportion to the open circuit voltage value of a single module in a generator system is that the value of the approximate local or approximate actual peak approximately equals to the MPP of module and its folds. Restarting the method every 20-25 seconds will bring power losses arising from scanning. A mechanism that perceives moments when a change occurs on environmental conditions and provides that the method automatically passes to scanning step is not included in this study. Also, even if there is no change in environmental conditions, restarting the method persistently will cause unnecessary calculation procedures and power losses. The same method was tested with a grid-connected PV system in [36].

#### IV. Simulation Study

The system developed with Matlab/Simulink to test some of the maximum power point tracking methods and to compare the performance of MPP tracking is given in Fig.7. In the system given in the Fig.7, a PV string is established by connecting three modules in series. A boost DC-DC converter is connected to the output of the PV string to track the maximum power point. The DC-DC converter is controlled by running different algorithms within the MPPT block and it is provided that the output current and voltage of the PV string can be adjusted to provide maximum power.

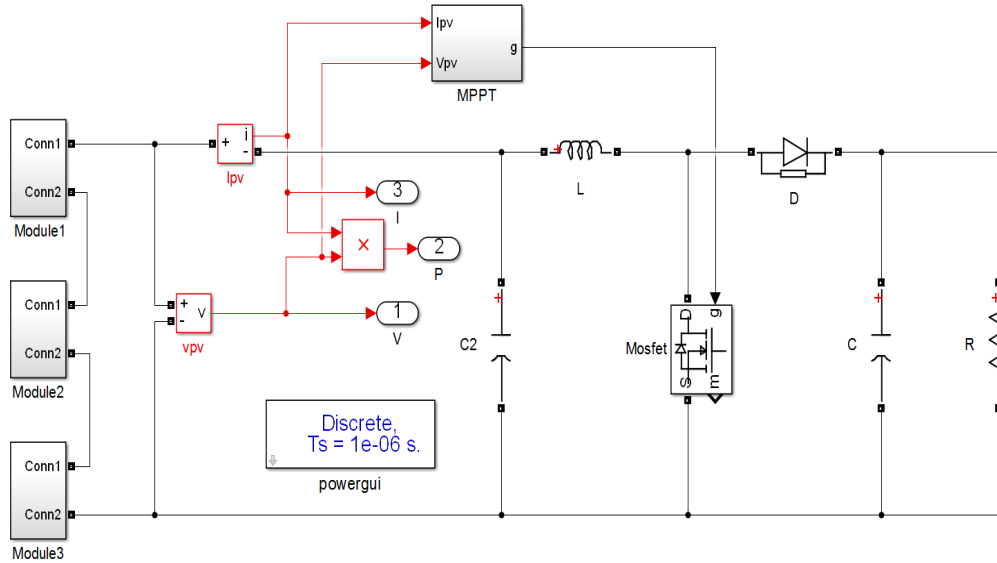

Fig.7 Simulation of the PV system in Matlab/Simulink.

The methods such as Incremental Conductance (INC), Perturb and Observe (P&O), Fuzzy Logic Controller (FLC), Open Circuit Voltage (Voc) and Short Circuit Current (Isc) have been tested through the model given in Fig.7. These methods can be applied both by directly controlling the duty cycle of DC-DC converter and using PI controller or hysteresis controller. The results obtained from both methods are similar, and they have advantages such as direct duty cycle control, simple control structure, short calculation time and no need to set PI coefficients [37]. In the simulation study, firstly changing the duty cycle directly or by PI controller has been examined. The simulation of the incremental conductance method has been tested with both duty cycle control methods in constant environmental conditions ( $G=1000W/m^2$ ,  $T=25^{\circ}C$ ). Besides, the expression given in the Incremental Conductance algorithm "if  $\frac{\Delta I}{\Delta V} = -\frac{I}{V}$  is MPP, the reference voltage value is not modified" has been changed as "if  $\frac{\Delta I}{\Delta V} + \frac{I}{V} \geq \pm \epsilon$  is MPP, V value cannot be modified" and step size has been tested for 0.1 (Fig.8(c)). The aim of this change is to reduce oscillations even in the larger step size by using  $\pm \epsilon$  range. Furthermore, duration of reaching the steady-state of method will be shortened since a large step range is selected.

Test results of INC method with direct duty cycle controller, INC method with PI controller and epsilon INC method with PI controller (EINC) are respectively given in Fig.8(a), (b) and (c). In Fig.9, the curves in Fig.8(a), (b) and (c) are shown together in a zoomed-in view. In the simulation, the step size was used as 0.01 in the methods given by graph (a) and (b).

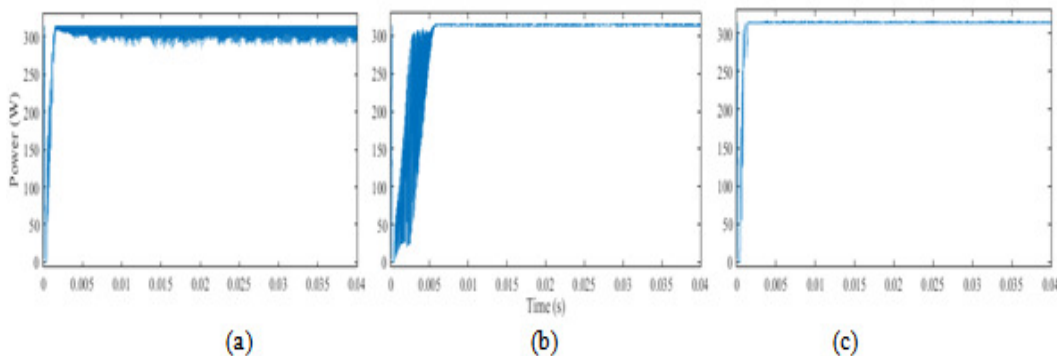

Fig.8 PV string output power; a) INC method with direct duty cycle controller, b) INC method with PI controller and c) Epsilon INC method with PI controller.



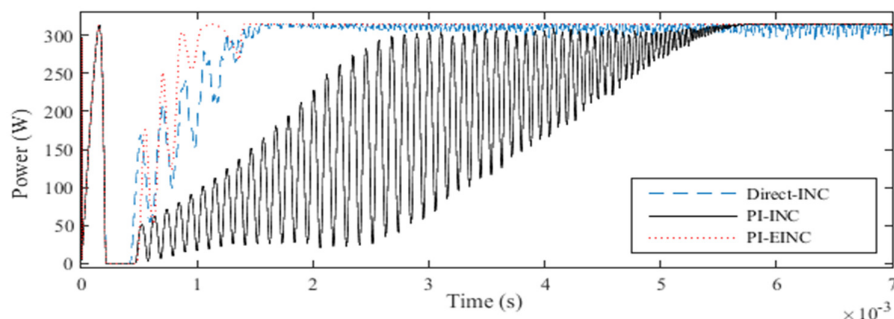

Fig.9 Curves given in the Fig.8(a), (b) and(c).

According to the Fig.8 and Fig.9, when direct duty cycle controller incremental conductance method is used, it is seen that the oscillations in the active power at the output of the PV string in steady-state are found to be ~ 20W (Fig.8(a)) and when PI controller incremental conductance method is used, oscillations are found to be ~1 W (Fig.8(b)) and when EINC method is used, oscillations are found to be ~0.7 W (Fig.8(c)). Reaching at the steady-state has taken 1.5ms, 5.7ms and 1.4ms, respectively. The best performance has been obtained for the epsilon INC method with PI controller. In the second phase of the simulation studies, the five MPPT algorithms have been simulated. These studies have been carried out in accordance with EN 50530 Test standards [37] and all methods have been applied by using a PI controller structure. The open circuit voltage value and short circuit current value of the PV generator should be measured in open-circuit voltage and short-circuit current method, respectively. In the simulation study, these values are obtained by modeling as given in Eqs. 16 and 17 without open-circuiting and/or short-circuiting the PV string.

$$V_{oc} = AV_T \ln\left(\frac{I_{ph}}{I_o} + 1\right) \tag{16}$$

$$I_{sc} = [I_{sco} + K_i(T - T_o)] \frac{G}{G_o} \tag{17}$$

Simulations of the five MPPT methods have been performed under the same conditions and the results are given in Fig.10, 11 and 12. Fig.10 shows PV string output powers and MPP tracking performance until they reach steady-state, Fig.11 shows PV string output powers and MPP tracking performance at steady-state, Fig.12 shows PV string output powers and MPP tracking performance when a step change (1000W/m<sup>2</sup> to 700W/m<sup>2</sup>) occurs in solar irradiation.

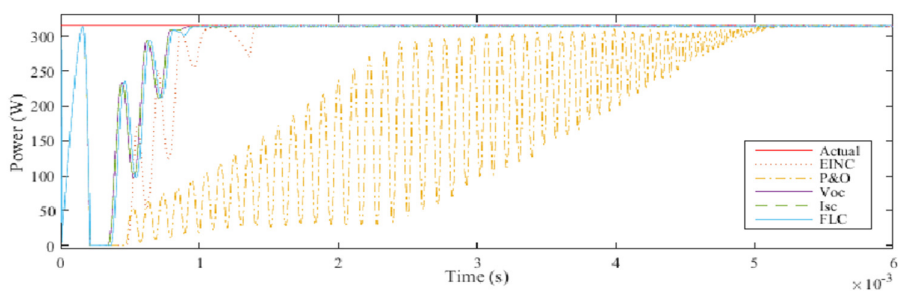

Fig.10 PV string output powers, until they reach steady-state.

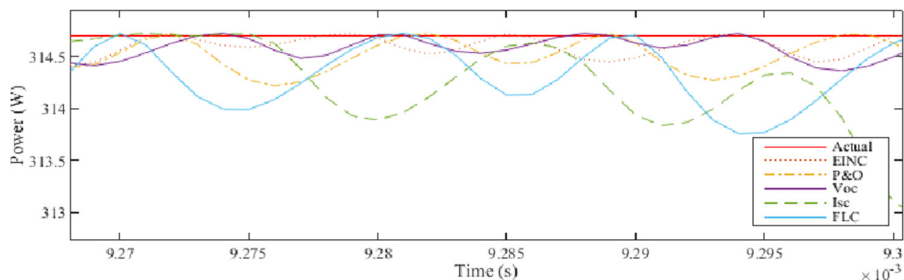

Fig.11 PV string output powers, at steady-state.

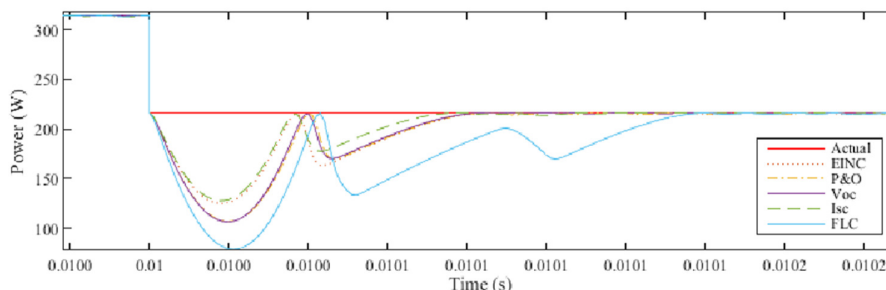
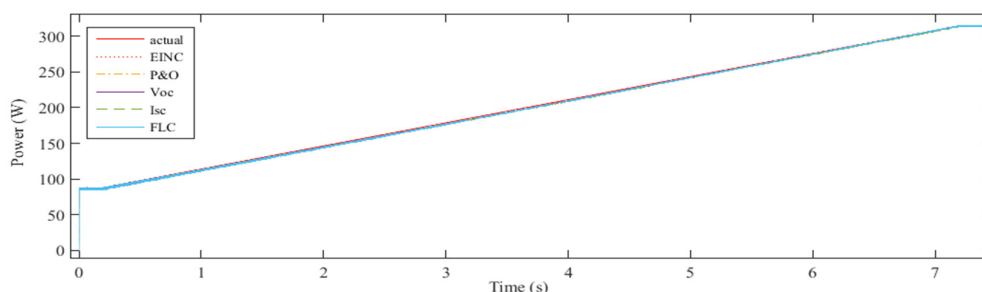

Fig.12 PV string output powers, when a step change occurs in solar irradiation.

When the Fig.10 is examined, it is seen that Voc, Isc and FLC methods are very close to each other and perform very well in terms of duration of reaching the steady-state. The EINC method is slightly similar to them. The P&O method has the longest duration of reaching steady-state (~5ms). According to the Fig.11, the method which has the lowest steady-state error rate is EINC method. When all methods are compared, rate of steady-state errors is found to be lower than 0.5%. When the solar irradiation is reduced from 1000W/m<sup>2</sup> to 700W/m<sup>2</sup>, all methods are able to track the MPP quickly (less than 0.1ms) (Fig.12).

The simulation results of the MPPT methods for the case where solar irradiation is changed from 300 W/m<sup>2</sup> to 1000 W/m<sup>2</sup> with a gradient of 100(W/m<sup>2</sup>)/sec are given in Fig.13. When the results are examined, it is seen that all MPPT methods are able to track the MPP quickly. In Fig.13(b) the results are given by zooming in the range of 3.29-3.35 sec. It has been observed that the oscillations in the Isc and FLC methods are more frequent than the other methods. The actual oscillation for all methods is less than the value of 0.5% and they are successfully able to track the curved change in MPP.



(a)

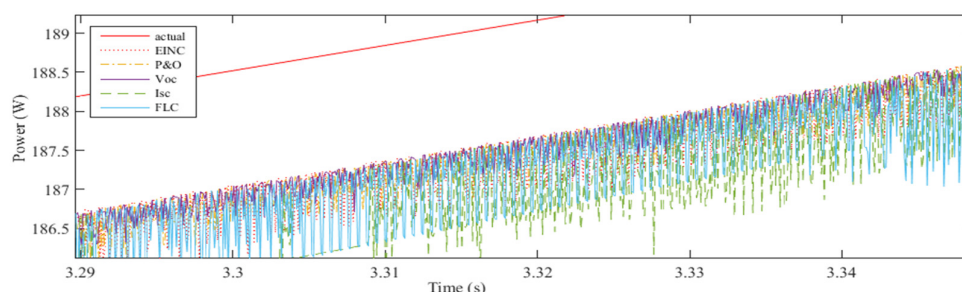

(b)

Fig.13 When the output power and solar irradiation of PV string is increased from 300 W/m<sup>2</sup> to 1000 W/m<sup>2</sup> with a gradient of 100(W/m<sup>2</sup>)/sec.

### V. Conclusion

In this study, widely used MPPT methods and hybrid methods developed from these methods are presented together with their advantages and disadvantages. Incremental Conductance, Perturb and Observe, Fuzzy Logic Controller, Open Circuit Voltage and Short Circuit Current methods are modeled with MATLAB/Simulink. The modeled MPPT methods have been tested under various irradiation densities which are stable, gradient and changing by following a curve. Simulation results of these five methods are compared and presented graphically.

## References

- [1] S. Sengar, Maximum power point tracking algorithms for photovoltaic system: A review, *International Review of Applied Engineering Research*, 4(2), 147-154, (2014).
- [2] T. Logeswaran, A. SenthilKumar, A Review of maximum power point tracking algorithms for photovoltaic systems under uniform and non-uniform irradiances, 4th International Conference on Advances in Energy Research 2013, ICAER 2013, *Energy Procedia*, 54, 228 – 235, (2014).
- [3] N. A. Kamarzaman, C. W. Tan, A comprehensive review of maximum power point tracking algorithms for photovoltaic systems, *Renewable and Sustainable Energy Reviews*, 37, 585–598, (2014).
- [4] N. Shah, C. Rajagopalan, Experimental evaluation of a partially shaded photovoltaic system with a fuzzy logic-based peak power tracking control strategy, *IET Renew. Power Gener.*, 10(1), 98–107, (2016).
- [5] H. Patel, V. Agarwal, MATLAB-based modeling to study the effects of partial shading on PV array characteristics, *IEEE Trans. Energy Convers.*, 23(1), 302–310, (2008).
- [6] C. Manickam, G. R. Raman, G. P. Raman, S.I. Ganesan, C. Nagamani, A hybrid algorithm for tracking of GMPP based on P&O and PSO with reduced power oscillation in string inverters, *IEEE Transactions On Industrial Electronics*, 63(10), 6097-6106, (2016).
- [7] V. Salas, E.Olías, A. Barrado, A. Lázaro, Review of the maximum power point tracking algorithms for stand-alone photovoltaic systems, *Solar Energy Materials & Solar Cells*, 90, 1555–1578, (2006).
- [8] P. Bhatnagar, R.K.Nema, Maximum power point tracking control techniques: State-of-the-art in photovoltaic applications, *Renewable and Sustainable Energy Reviews*, 23, 224–241, (2013).
- [9] E. I. Ortiz-Rivera, F.Z. Peng, Analytical model for a photovoltaic module using the electrical characteristics provided by the manufacturer data sheet, in *IEEE 36th Conference on Power Electronics Specialists*, 2087–2091, (2005).
- [10] A. Ortiz-Conde, D. Lugo-Muñoz, F. J. García-Sánchez, An explicit multiexponential model as an alternative to traditional solar cell models with series and shunt resistances, *IEEE Journal of Photovoltaics*, 2(3), 261-268, (2012).
- [11] S.K. Hosseini, S. Taheri, M. Farzaneh, H. Taheri, An approach to precise modeling of photovoltaic modules under changing environmental conditions, *IEEE Electrical Power and Energy Conference (EPEC)*, (2016).
- [12] W. Kim, W. Choi, A novel parameter extraction method for the one-diode solar cell model, *Solar Energy*, 84, 1008-1019 (2010).
- [13] K. Ishaque, Z. Salam, and H. Taheri, Simple, fast and accurate two diode model for photovoltaic modules, *Solar Energy Materials and Solar Cells*, 95, 586-594, (2011).
- [14] R. Mahto, P. Zarkesh-Ha and O. Lavrova, MOSFET-based modeling and simulation of photovoltaics module, 2016 *IEEE 43rd Photovoltaic Specialists Conference (PVSC)*, Portland, OR, 3078-3081, (2016).
- [15] L. Sandrolini, M. Artioli, and U. Reggiani, Numerical method for the extraction of photovoltaic module double-diode model parameters through cluster analysis, *Applied Energy*, 87, 442-451, (2010).
- [16] K. Nishioka, N. Sakitani, Y. Uraoka, and T. Fuyuki, Analysis of multicrystalline silicon solar cells by modified 3-diode equivalent circuit model taking leakage current through periphery into consideration, *Solar Energy Mater. Solar Cells*, 91, 1222– 1227, (2007).
- [17] A. Chatterjee, A. Keyhani, Thevenin's equivalent of photovoltaic source models for MPPT and power grid studies, 2011 *IEEE Power and Energy Society General Meeting*, San Diego, CA, 1-7, (2011).
- [18] S. K. Varshney, Z. A. Khan, M. A. Husain and A. Tariq, A comparative study and investigation of different diode models incorporating the partial shading effects, 2016 *International Conference on Electrical, Electronics, and Optimization Techniques (ICEEOT)*, Chennai, 3145-3150, (2016).
- [19] S. Vergura, A complete and simplified datasheet-based model of PV cells in variable environmental conditions for circuit simulation, *Energies*, 9(5), 2016.
- [20] J. Cubas, S. Pindado, C. de Manuel, Explicit expressions for solar panel equivalent circuit parameters based on analytical formulation and the Lambert W-Function, *Energies*, 7, 4098-4115, (2014).
- [21] M. G. Villalva, J. R. Gazoli, E. R. Filho, Comprehensive approach to modeling and simulation of photovoltaic arrays, *IEEE Transactions On Power Electronics*, 24(5), 1198-1208, (2009).
- [22] X. H. Nguyen, M. P. Nguyen, Mathematical modeling of photovoltaic cell/module/arrays with tags in Matlab/Simulink, *Environ. Syst. Res.*, 4(24), (2015).
- [23] H. A. Sher, A.F. Murtaza, A. Noman, K. E. Addoweesh, K. Al-Haddad, M. Chiaberge, A new sensorless hybrid MPPT algorithm based on fractional short-circuit current measurement and P&O MPPT, *IEEE Transactions on Sustainable Energy*, 6(4), 1426-1434, (2015).
- [24] A. R.Reisi, M. H.Moradi, S. Jamasb, Classification and comparison of maximum power point tracking techniques for photovoltaic system: A review, *Renewable and Sustainable Energy Reviews*, 19, 433–443, (2013).
- [25] K. Ishaque, Z.Salam, A review of maximum power point tracking techniques of PV system for uniform insolation and partial shading condition, *Renewable and Sustainable Energy Reviews*, 19, 475–488, (2013).
- [26] F. Zhang, K. Thanapalan, A. Procter, S. Carr, J. Maddy, Adaptive hybrid maximum power point tracking method for a photovoltaic system, *IEEE Transactions on Energy Conversion*, 28(2), 353-360, (2013).
- [27] N. S. D'Souza, L. A. C. Lopes, X.J. Liu, An intelligent maximum power point tracker using peak current control, 2005 *IEEE 36th Power Electronics Specialists Conference*, Recife, 2005, pp. 172-177, (2005).
- [28] N. S. D'Souza, L. A. C. Lopes, X.J. Liu, Comparative study of variable size perturbation and observation maximum power point trackers for PV systems, *Electric Power Systems Research*, 80, 296–305, (2010).
- [29] S. Baraskar1, S. K. Jain, P. K. Padhy, Fuzzy logic assisted P&O based Improved MPPT for photovoltaic systems, *International Conference on Emerging Trends in Electrical, Electronics and Sustainable Energy Systems (ICETEESES-16)*, 250-255, (2016).
- [30] C.-C. Hua, Y.-H. Fang, W.-T. Chen, Hybrid maximum power point tracking method with variable step size for photovoltaic systems, *IET Renew. Power Gener.*, 10(2), 9127–132, (2016).
- [31] A. Belkaid, I. Colak, K. Kayisli, Implementation of a modified P&O-MPPT algorithm adapted for varying solar radiation conditions, *Electr. Eng.*, 99, 839–846, (2017).
- [32] R. Abdul-Kalaam, S.M. Muyeen, A. Al-Durra, Review of maximum power point tracking techniques for photovoltaic system, *Global Journal of Control Engineering and Technology*, 2, 8-18 (2016).
- [33] Q. Mei, M. Shan, L. Liu, J. M. Guerrero, A novel improved variable step-size incremental-resistance MPPT method for PV systems, *IEEE Transactions on Industrial Electronics*, 58(6), 2427-2434, (2011).
- [34] K.Vardar, Doğru akım motor hızının bulanık mantık ile kontrolü, Yüksek Lisans Tezi, Dumlupınar Üni. Elektrik-Elektronik Mühendisliği Anabilim Dalı, (2004).
- [35] Z. Salam, J. Ahmed, B.S. Merugu, The application of soft computing methods for MPPT of PV system: A technological and status review, *Applied Energy*, 107, 135–148, (2013).

- [36] Shah, N., Chudamani, R., A novel algorithm for global peak power point tracking in partially shaded grid-connected PV system, Proc. Int. Conf. IEEE Power and Energy Conf. (PECon), Kota kinabalu, Sabah, Malaysia, 2–5 December 2012, 558–563, (2012).
- [37] K. Ishaque , Z.Salam ,G. Lauss, The performance of perturb and observe and incremental conductance maximum power point tracking method under dynamic weather conditions, Applied Energy 119, 228–236, (2014).
- [38] H. A. Sher, A.A. Rizvi, K.E. Addoweesh, K. Al-Haddad, A single-stage stand-alone photovoltaic energy system with high tracking efficiency, IEEE Transactions on SustainableEnergy, 8(2), 755-762, (2017).
- [39] S. Hajjghorbani, M. Radzi, M. Ab Kadir, S. Shafie, R. Khanaki, M. Maghami, Evaluation of fuzzy logic subsets effects on maximum power point tracking for photovoltaic system, International Journal of Photoenergy, 2014 (2014).
- [40] N. Karami, N. Moubayed, R. Outbib, General review and classification of different MPPT Techniques, Renewable and Sustainable Energy Reviews, 68, 1–18, (2017).

Yunus Emre Yağın "Investigation of MPPT Methods Used In PV Systems." IOSR Journal of Electrical and Electronics Engineering (IOSR-JEEE) 13.2 (2018): 84-95.